



NSTHAI

☆ Design patent NO. :
201130028317.3

☆ Utility model patent NO.
: 201120064092.1

INSTRUCTION MANUAL



NSC1024R Solar Light Controller



บริษัท นอร์ธเทอรัล ชันไซน์ จำกัด

เลขที่ 82/33 ซ.รัตนวิเบศร์ 26/1 ต.บางกระสอบ อ.เมือง จ.นนทบุรี 11000

โทร. 02-9657588 , 081-8465426 , 086-3411861 แฟกซ์ 02-9657599

E-Mail : sales@nsthai.com

Website : <http://www.nsthai.com>

NSC1024R (LS1024R) Solar Light Controller

Installation and Operation Manual

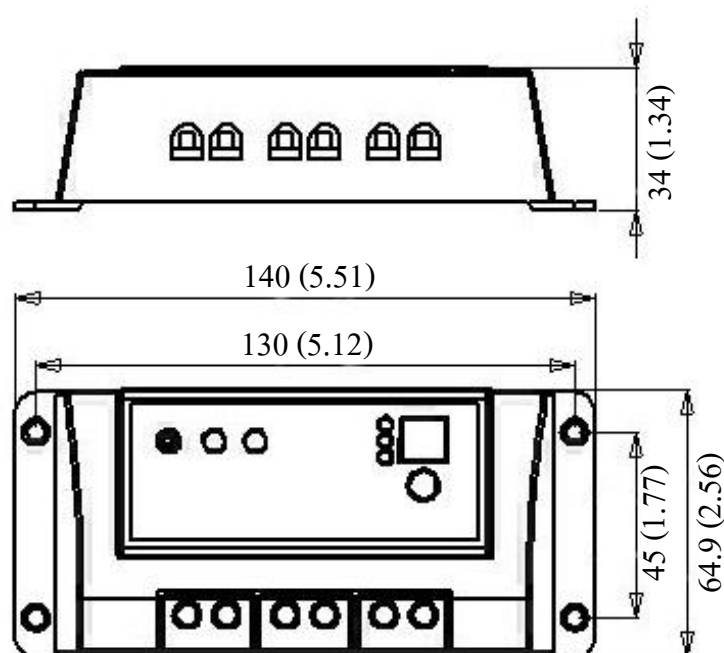

Specification Summary

| | |
|------------------------------------|-------------|
| Nominal system voltage | 12 / 24VDC* |
| Maximum PV input voltage | 50V |
| Nominal charge / discharge current | 10A |



* The controller will recognize the system rated voltage when start up. If the battery voltage is lower than 18V, it will recognize the system as 12V. If the battery voltage is greater than 18V, it will recognize the system as 24V.

1. Important Safety Information

Save These Instructions

This manual contains important safety, installation and operating instructions.

The following symbols are used throughout this manual to indicate potentially dangerous conditions or mark important safety instructions, please take care when meeting these symbols.

| | |
|--|---|
|  | WARNING: Indicates a potentially dangerous condition. Use extreme caution when performing this task. |
|  | CAUTION: Indicates a critical procedure for safe and proper operation of the controller. |
|  | NOTE: Indicates a procedure or function that is important for the safe and proper operation of the controller. |

General Safety Information

- Read all of the instructions and cautions in the manual before beginning installation.
- There are no user serviceable parts inside the controller. Do not disassemble or attempt to repair it.
- Install external fuses/breakers as required.
- Disconnect the solar module and fuse/breakers near to battery before installing or adjusting the controller.
- Do not allow water to enter the controller.
- Confirm that power connections are tightened to avoid excessive heating from loose connection.

2. General Information

2.1 Product Overview

Thank you for selecting NSC series solar light controller that adopts the most advanced digital technique and operates fully automatically. The Pulse Width Modulation (PWM) battery charging can greatly increase the lifetime of battery. It has various unique functions and quite easy to use, such as:

- 12/24V automatic recognition
- High efficient Series PWM charging, increase the battery lifetime and improve the solar system performance.
- Use MOSFET as electronic switch, without any mechanical switch

- Widely used, automatically recognize day/night.
- Digital LED menu, only one key solve all setting simply
- Intelligent timer function with 1-15 hours option
- Unique dual timer function, enhance the flexibility of street light system.
- Gel, Sealed and Flooded battery type option.
- Adopt temperature compensation, correct the charging and discharging parameters automatically and improve the battery lifetime.
- Electronic protection: Overheating, over charging, over discharging, overload, and short circuit.
- Reverse protection: any combination of solar module and battery.

The controller is for off-grid solar system, especially in solar light system, and protects the battery from being over charged by the solar module and over discharged by the loads. The charging process has been optimized for long battery life and improved system performance. The comprehensive self-diagnostics and electronic protection functions can prevent damage from installation mistakes or system faults.

Though the controller is easy to operate and use, please take your time to read this manual and become familiar with it. This will help you make full use of all the functions and improve your solar PV system.

2.2 Product Features

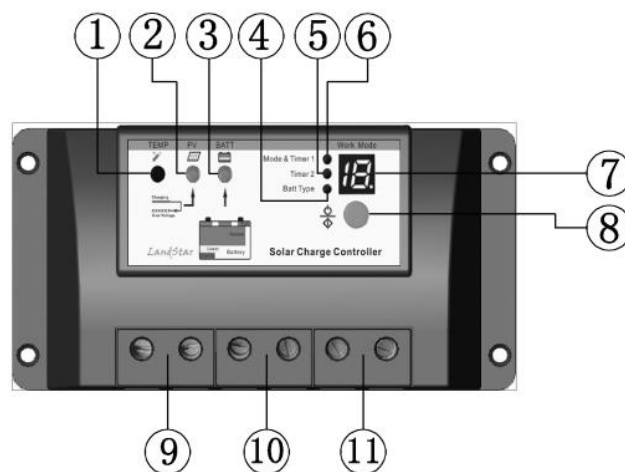

Figure 2-1 characteristics

1 –Temperature Sensor

Measure ambient temperature and make temperature compensation for charging and discharging.

2 – Charging status LED indicator

An LED indicator that shows charging status and also indicates when battery voltage is higher than over voltage disconnect voltage.

3 – Battery status LED indicator

A LED indicator that shows battery status

4 – Battery type setting indicator

The indicator will be on when select battery type.

5 – Timer 2 setting indicator

The indicator will be on when set timer 2.

6 – Timer 1 setting indicator

The indicator will be on when set timer 1.

7 –LED digital display

Display the load work mode and status

8 –Setting button

Set load work mode and select battery type. (in manual mode used for load ON/OFF)

9 –Solar Module Terminals

Connect solar modules.

10 –Battery Terminals

Connect batteries.

11 –Load Terminals

Connect loads.

3. Installation Instructions

3.1 General Installation Notes

- Read through the entire installation section first before beginning installation.
- Be very careful when working with batteries. Wear eye protection. Have fresh water available to wash and clean any contact with battery acid.
- Uses insulated tools and avoid placing metal objects near the batteries.
- Explosive battery gasses may be present during charging. Be certain there is sufficient ventilation to release the gasses.
- Avoid direct sunlight and do not install in locations where water can enter the controller.
- Loose power connections and/or corroded wires may result in resistive connections that melt wire insulation, burn surrounding materials, or even cause fire. Ensure tight connections and use cable clamps to secure cables and prevent them from swaying in mobile applications.
- Use with Gel, Sealed or Flooded batteries only.

- Battery connection may be wired to one battery or a bank of batteries. The following instructions refer to a singular battery, but it is implied that the battery connection can be made to either one battery or a group of batteries in a battery bank.
- Select the system cables according to $3A/mm^2$ current density

3.2 Mounting



NOTE: When mounting the controller, ensure free air through the controller heat sink fins. There should be at least 6 inches (150 mm) of clearance above and below the controller to allow for cooling. If mounted in an enclosure, ventilation is highly recommended.



WARNING: Risk of explosion! Never install the controller in a sealed enclosure with flooded batteries! Do not install in a confined area where battery gassed can accumulate.

Step 1: Choose Mounting Location

Locate the controller on a vertical surface protected from direct sun, high temperature, and water. And make sure good ventilation.

Step 2: Check for clearance

Place the controller in the location where it will be mounted. Verify that there is sufficient room to run wires and that there is sufficient room above and below the controller for air flow.

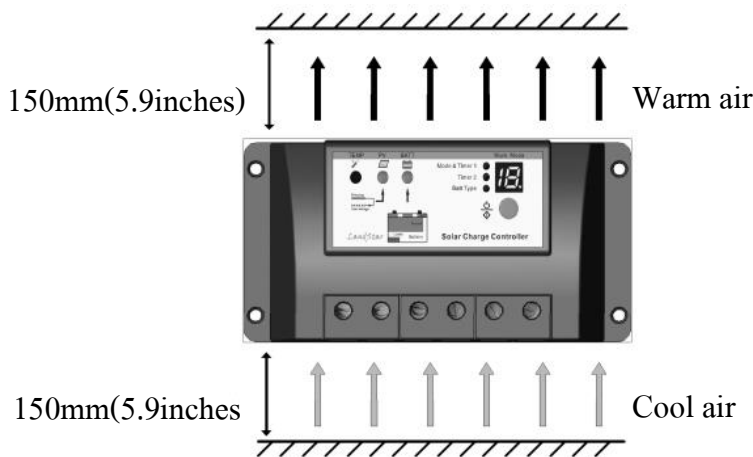

Figure 3-1 Mounting and cooling

Step 3: Mark Holes

Use a pencil or pen to mark the four (4) mounting hole locations on the mounting surface.

Step 4: Drill Holes

Remove the controller and drill 4.5mm holes in the marked locations.

Step 5: Secure Controller

Place the controller on the surface and align the mounting holes with the drilled holes in step 4.
Secure the controller in place using the mounting screws.

3.3 Wiring



NOTE: A recommended connection order has been provided for maximum safety during installation.



NOTE: The controller is a common positive ground controller.



CAUTION: Don't connect the loads with surge power exceeding the ratings of the controller.



CAUTION: For mobile applications, be sure to secure all wiring. Use cable clamps to prevent cables from swaying when the vehicle is in motion. Unsecured create loose and resistive connections which may lead to excessive heating and/or fire.

Step1: Battery Wiring



WARNING: Risk of explosion or fire! Never short circuit battery positive (+) and negative (-) or cables

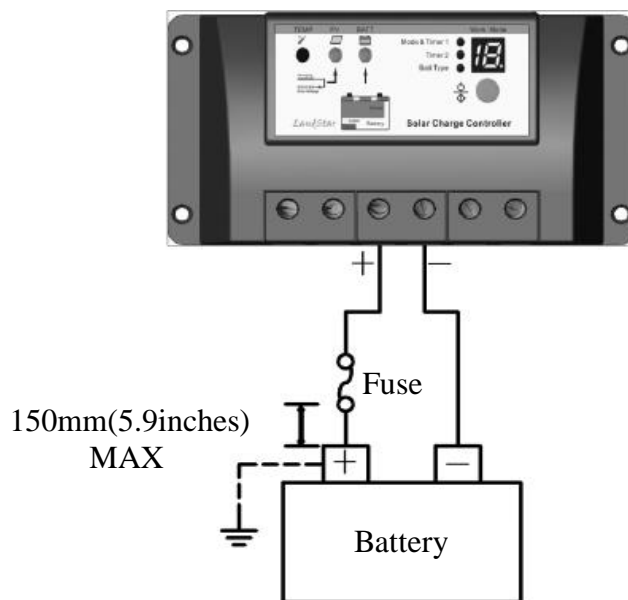

Figure 3-2 Battery connecting

Before battery is connected, make sure that battery voltage is greater than 6V so as to start up the controller. If system is 24V, make sure battery voltage is not less than 18V. System voltage can only be automatically recognized when controller start up for the first time.

When install fuse, make sure that the biggest distance between the fuse holder and the positive terminal of battery is 150mm. **Do not insert a fuse at this time.** Confirm the connection correct and turn on the power.

Step 2: Load Wiring

The controller loads can be connected to such electrical equipments as lights, pumps, motors and others. Controller offers power to loads through the battery voltage.

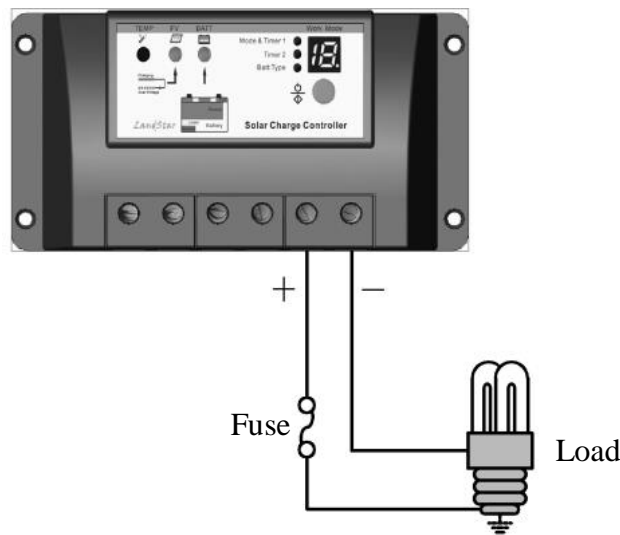

Figure 3-3 Load Wiring

Connect the positive (+) and negative (-) of loads to controller load terminals as shown in Figure 3-3. The load terminal be exist voltage, connect carefully to avoid short circuit.

An in-line fuse holder should be wired in series in the load positive (+) or negative (-) wire as show in Figure 3-3. **Do not insert a fuse at this time.** Confirm the connection correct and turn on the power.

If wiring the load connection to a load distribution panel, each load circuit should be fused separately. The total load draw should not exceed the load rated current of controller.

Step 3: Solar wiring



WARNING: Risk of electric shock! Exercise caution when handling solar wiring. The solar module(s) high voltage output can cause severe shock or injury. Be careful operation when installing solar wiring.

The controller can accept 12V, 24V nominal off-grid solar module(s). Grid-tie solar module(s) may be used if the open circuit voltage of solar module doesn't exceed the Maximum PV input voltage of the controller. The solar module(s) work voltage must be equal to or greater than the system voltage.

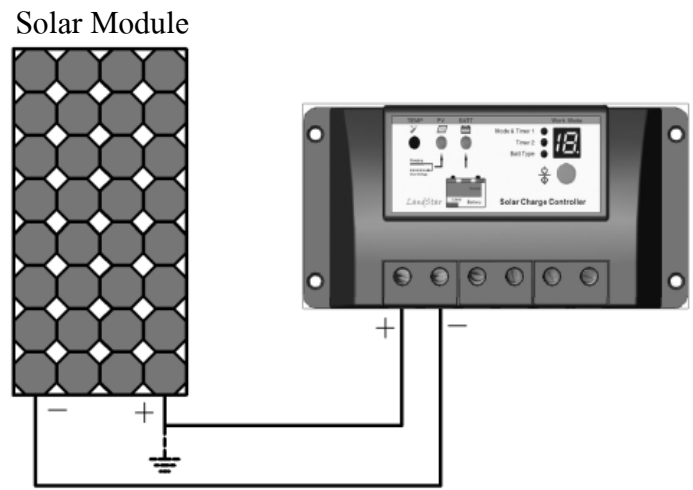

Figure 3-4 Solar wiring

Step 4: Confirm Wiring

Double-check the wiring in step 1 through 3. Confirm correct polarity at each connection. Verify that all six terminals are tightened.

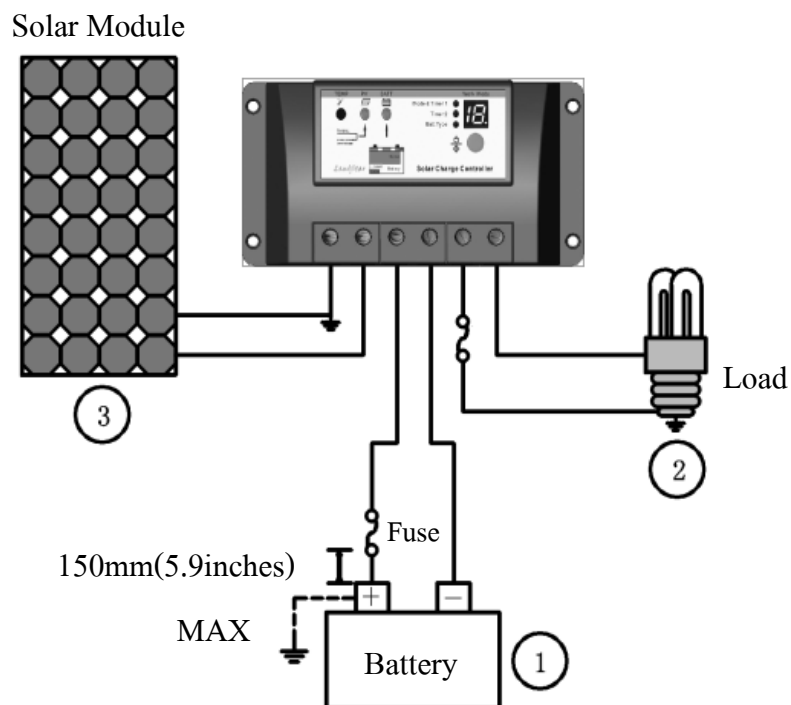

Figure 3-5 System wiring review

Step 5: Install Fuse

Install a suitable fuse in each fuse holder in the following order:

1. Battery circuit
2. Load circuit

Step 6: Confirm power on

When battery power is applied and the controller starts up, the battery LED indicator will be green.

If the controller doesn't start up, or the battery status LED error exists, please refer to section 5 for troubleshooting.

4. Operation

4.1 PWM Technology (Series Pulse Width Modulation)

The controller adopts the advanced series pulse width modulation (PWM) charging mode. With range of 0-100%, it can charge the battery quickly and stably under any condition of solar photovoltaic system. PWM charging mode use automatic conversion duty ratio pulses to charge the battery. The battery can be fully charged safety and rapidly with the pulse current. Intermissions make some oxygen and hydrogen generated by chemical reaction chemically combined again and absorbed. It can eliminate concentration polarization and ohm polarization naturally and reduce the internal pressure of the battery so that the battery can absorb more power. pulse current charging mode makes battery have more time to react, which reduces the gassing volume and makes battery improve the acceptance rate of charging current.

4.2 Battery Charging Information

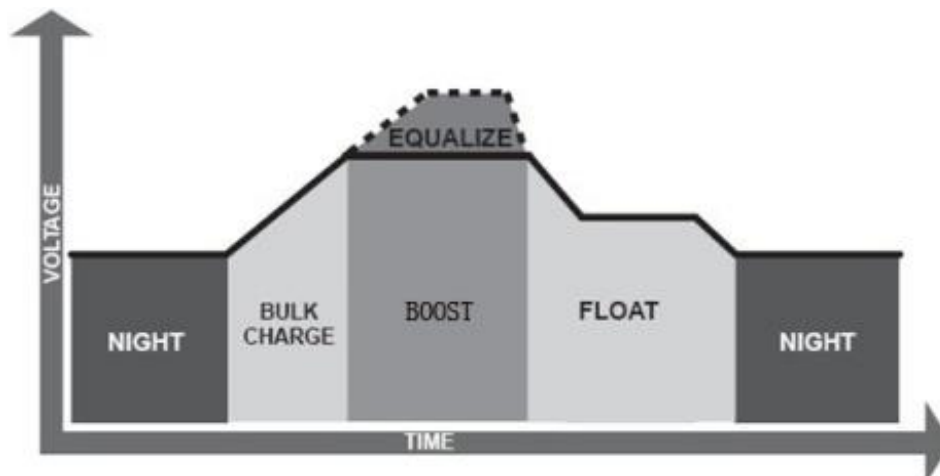

Figure 4-1 PWM Charging mode

● Bulk Charge

In this stage, the battery voltage has not yet reached boost voltage and 100% of available solar power is used to charge the battery.

● Boost Charge

When the battery has recharged to the Boost voltage setpoint, constant-voltage regulation is used to prevent heating and excessive battery gassing. The Boost stage remains 120 minutes and then goes to Float Charge.

● Float Charge

After the battery is fully charged in Boost voltage stage, the controller reduces the battery voltage to Float voltage set point. When the battery is fully recharged, there will be no more chemical reactions and all the charge current transmits into heat and gas at this time. Then the controller reduces the voltage to the floating stage, charging with a smaller voltage and current. It will reduce the temperature of battery and prevent the gassing, also charging the battery slightly at the same time. The purpose of Float stage is to offset the power consumption caused by self consumption and small loads in the whole system, while maintaining full battery storage capacity.

In Float stage, loads can continue to draw power from the battery. In the event that the system load(s) exceed the solar charge current, the controller will no longer be able to maintain the battery at the Float setpoint. Should the battery voltage remains below the Boost setpoint, the controller will exit Float stage and return to Bulk charge.

● Equalize Charge



WARNING: Risk of explosion!

Equalizing flooded battery can produce explosive gases, so well ventilation of battery box is necessary



NOTE: Equipment damage!

Equalization may increase battery voltage to the level damaging to sensitive DC loads.

Ensure that all load allowable input voltages are greater than the equalizing charging set point voltage.



NOTE: Equipment damage!

Over-charging and excessive gas precipitation may damage the battery plates and activate material shedding on them. Too high an equalizing charge or for too long may cause damage. Please carefully review the specific requirements of the battery used in the system.

Certain types of batteries benefit from periodic equalizing charge, which can stir the electrolyte, balance battery voltage and complete chemical reaction. Equalizing charge increases the battery voltage, higher than the standard complement voltage, which gasifies the battery electrolyte.

If the battery is being over discharged, the solar controller will automatically turn to equalize charging stage, and the equalize stage remain 120mins. Equalize charge and boost charge are not carried out constantly in a full charge process to avoid too much gas precipitation or overheating of battery.

4.3 LED Indicators

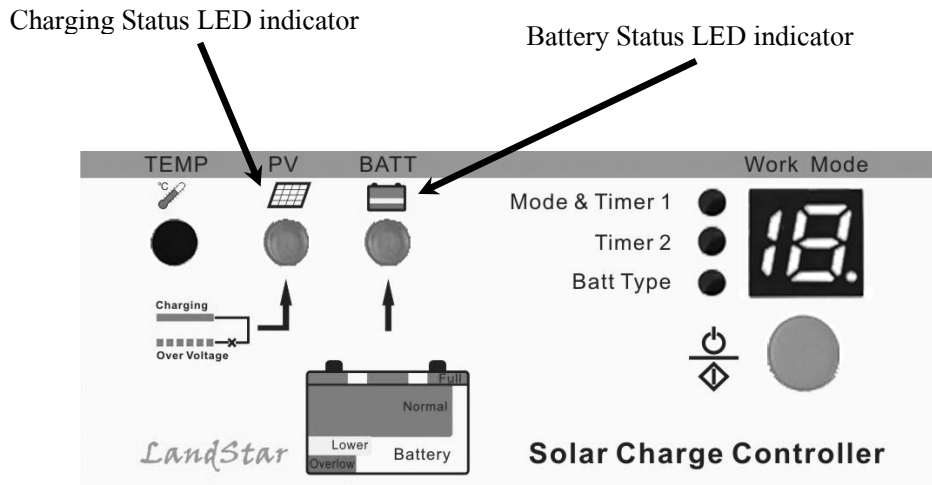

Figure 4-2 LED indicators

• Charging status indicator

GREEN ON whenever sunlight is available for battery charging,

GREEN FAST FLASHING when system over voltage.

Please refer to section 5 for troubleshooting.

Charging Status LED indicator

Table 4-1

| Color | Indicator | Charging Status |
|-------|---------------|-----------------|
| Green | On Solid | Charging |
| Green | Fast Flashing | Over voltage |

• Battery status indicator

GREEN ON when battery voltage in normal range

GREEN SLOWLY FLASHING when battery full

ORANGE ON when battery under voltage

RED ON when battery over discharged

Please refer to section 5 for troubleshooting.

Battery status LED indicator

Table 4-2

| Color | Indicator | Battery Status |
|--------|-----------------|-----------------|
| Green | On solid | Normal |
| Green | Slowly Flashing | Full |
| Orange | On solid | Under voltage |
| Red | On solid | Over discharged |

● **Load status indicator:**

When the load amp is 1.25times of rated current for 60 seconds, or the load amp is 1.5 times of rated current for 5 seconds (overload); or load amp is more than 3.5 times of rated current(Short Circuit) ,the LED digital tube shows “L” with slowly flashing simultaneously. Please refer to section 5 for trouble shooting.

Load status LED indicator

Table 4-3

| Color | LED digital tube | Load status |
|-------|--------------------------|---------------------------|
| Red | “L” with slowly flashing | Overload or short circuit |

● **Overheating protection indicator:**

When heat sink of the controller exceeds 85°C, the controller will automatically cut input and output circuit, with LED digital tube showing “H” with slowly flashing simultaneously. Please refer to section 5 for trouble shooting.

Overheating protection indicator

Table 4-4

| Color | LED digital tube | System status |
|-------|--------------------------|------------------------|
| Red | “H” with slowly flashing | Controller overheating |

4.4 Setting Operation

Dual timer function

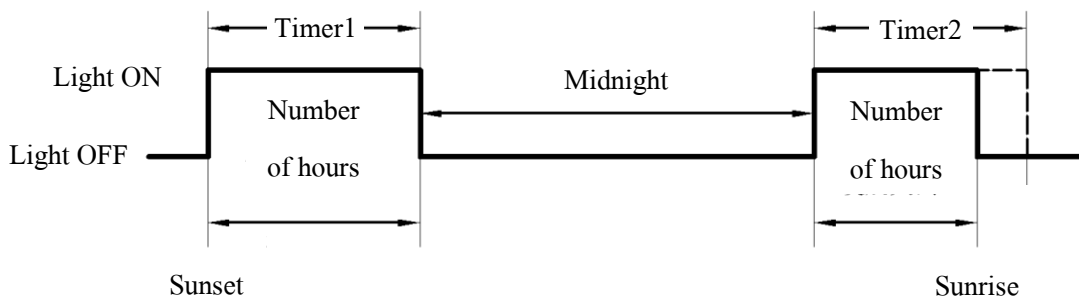

The default night length is 10 hours. The controller can learn the night length referring to the previous night so as to adapt to the different seasons. However, it will take some time to learn it.



Notes: when the “OFF” time set at timer 2 is later than local sunrise time, the controller will turn off the load output at the sunrise time, which shows light control first!

● Load Control Settings

1. Dusk to Dawn

When solar module voltage goes below the point of NTTV (Night Time Threshold Voltage) at sunset, the controller will recognize the starting voltage and turn on the load after 10 minutes delay. When solar module voltage goes above point of DTTV (Day Time Threshold Voltage), the solar controller will recognize the starting voltage and turn off the load after 10 minutes delay.

2. Light ON + Timer

When solar module voltage goes below the point of NTTV (Night Time Threshold Voltage) at sunset; the solar controller will recognize the starting voltage and turn on the load after 10 minutes delay. The load will be on for several hours which users set through LED digital tube. The controller has dual timer function. Please refer to table 4-5 “Load Work Mode Setting”.

3. Test mode

This mode is the same as Dusk to Dawn. But there is no 10 minutes delay when controller recognizes the starting voltage. When below the starting voltage, the controller will turn on the load, if higher, it will turn off load. The test mode makes it easy to check the system installation.

4. ON/OFF mode

This mode is to turn ON and OFF the load by manual.

● Load Work Mode Setting

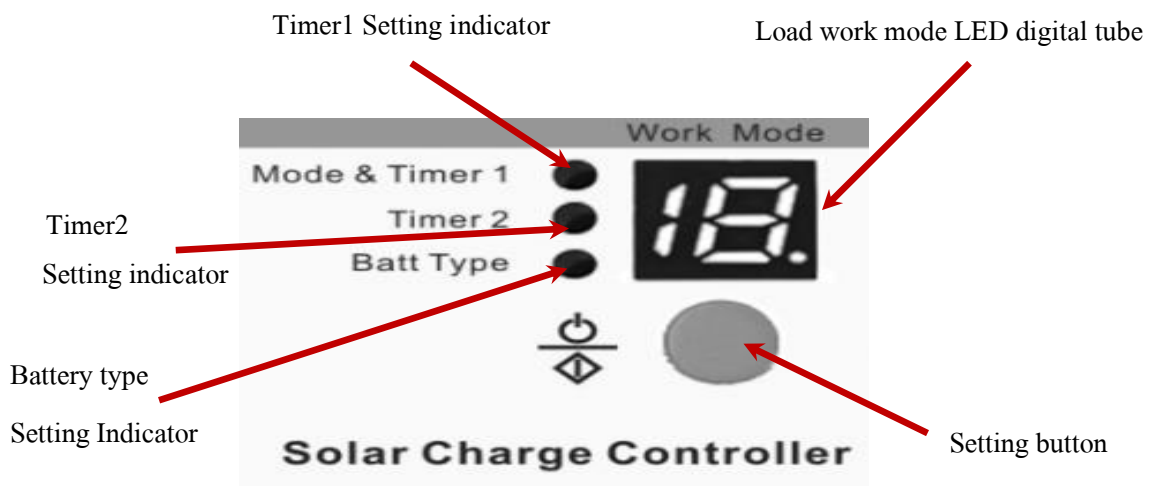

Figure 4-3 Setting operation indicating

Press the setting button once and setting indicators will be changed once among timer 1, timer2 and battery type.

When timer 1 setting indicator is on, press the setting button for more than 5 seconds till the LED digital tube flashes. Then press the setting button till the desired number appears according to the following table. The setting is finished when the digital tube stop flashing.

Timer 2 setting is the same as timer 1 when the setting indicator is on timer2

Load work mode

Table 4-5

| Timer1 | LED Digital No. |
|---|------------------------|
| Enable | n |
| Dusk to Dawn, Load will be on all night | 0 |
| Load will be on for 1 hour after ten minutes delay since sunset | 1 |
| Load will be on for 2 hours after ten minutes delay since sunset | 2 |
| Load will be on for 3 hours after ten minutes delay since sunset | 3 |
| Load will be on for 4 hours after ten minutes delay since sunset | 4 |
| Load will be on for 5 hours after ten minutes delay since sunset | 5 |
| Load will be on for 6 hours after ten minutes delay since sunset | 6 |
| Load will be on for 7 hours after ten minutes delay since sunset | 7 |
| Load will be on for 8 hours after ten minutes delay since sunset | 8 |
| Load will be on for 9 hours after ten minutes delay since sunset | 9 |
| Load will be on for 10 hours after ten minutes delay since sunset | 10 |
| Load will be on for 11 hours after ten minutes delay since sunset | 11 |
| Load will be on for 12 hours after ten minutes delay since sunset | 12 |
| Load will be on for 13hours after ten minutes delay since sunset | 13 |
| Load will be on for 14 hours after ten minutes delay since sunset | 14 |
| Load will be on for 15 hours after ten minutes delay since sunset | 15 |
| Test mode | 16 |
| ON/OFF mode | 17 |

Load work mode

Table 4-6

| Timer2 | LED Digital No. |
|---|-----------------|
| Enable | n |
| Load will be on for 1 hour before sunrise | 1 |
| Load will be on for 2 hours before sunrise | 2 |
| Load will be on for 3 hours before sunrise | 3 |
| Load will be on for 4 hours before sunrise | 4 |
| Load will be on for 5 hours before sunrise | 5 |
| Load will be on for 6 hours before sunrise | 6 |
| Load will be on for 7 hours before sunrise | 7 |
| Load will be on for 8 hours before sunrise | 8 |
| Load will be on for 9 hours before sunrise | 9 |
| Load will be on for 10 hours before sunrise | 10 |
| Load will be on for 11 hours before sunrise | 11 |
| Load will be on for 12 hours before sunrise | 12 |
| Load will be on for 13hours before sunrise | 13 |
| Load will be on for 14 hours before sunrise | 14 |
| Load will be on for 15 hours before sunrise | 15 |



Notes: If timer 1 is Dusk to Dawn(0), Test mode (16) or ON/OFF mode (17), the timer 2 will be enabled.

● Battery Type Setting

When battery type setting indicator is on, press the setting button for more than 5 seconds till the LED digital tube flashes. Then press the setting button till the desired number appears according to the following table. The setting is finished till the LED digital display stops flashing.

Battery type setting

Table 4-7

| Battery type | Digital tube display |
|--------------------------|----------------------|
| Sealed lead acid battery | 1 |
| Gel battery | 2 |
| Flooded battery | 3 |

5. Protection, Troubleshooting and Maintenance

5.1 Protection

- **PV Array Short Circuit**

If PV array short circuit occurs, clear it to resume normal operation.

- **Load Overload**

If the load current exceeds the maximum load current rating, the controller will disconnect the load. The greater the overload, the faster the load will be disconnected. A small overload could take a few minutes to disconnect.

Overloading must be cleared up through reapply power or pressing the setting button.

- **Load Short Circuit**

Fully protected against load wiring short-circuit. After one automatic load reconnect attempt, the fault must be cleared by reapply power or pressing the setting button.

- **PV Reverse Polarity**

Fully protection against PV reverse polarity, no damage to the controller will result. Correct the miswire to resume normal operation.

- **Battery Reverse Polarity**

Fully protection against battery reverse polarity, no damage to the controller will result. Correct the miswire to resume normal operation.

- **Damaged Local Temperature Sensor**

If the temperature sensor short-circuited or damaged, the controller will be charging or discharging at the default temperature 25°C to prevent the battery damaged from overcharging or over discharged.

- **Overheating Protection**

If the temperature of the controller heat sink exceeds 85°C, the controller will automatically start the overheating protection.

- **High Voltage Transients**

Battery is protected against high voltage transients. In lightning prone areas, additional external suppression is recommended.

5.2 Troubleshooting

Trouble Shooting

Table 5-1

| Faults | Possible reasons | Troubleshooting |
|---|--|---|
| Charging LED indicator off during daytime when sunshine falls on PV modules properly. | PV array disconnection | Check that PV and battery wire connections are correct and tight. |
| Green charging LED indicator fast flashing | Battery voltage higher than over voltage disconnect voltage(OVD) | Check if battery voltage over high. Disconnect the solar module |
| Battery LED indicators are orange | Battery under voltage | Load output is normal, charging LED indicator will return to green automatically when fully charged. |
| Battery LED indicators RED color and loads not working. | Battery over discharged | The controller cut off the output automatically, LED indicator will return to green automatically when fully charged. |
| Digital tube displays “L” with red slowly flashing | Over load or short circuit | <p>Overload: Please reduce the load and press the button once, the controller will resume to work after 3s;</p> <p>Short circuit: when the first short-circuit occurs, the controller will automatically resume to work after 10s; when a second short-circuit occurs, press the button, the controller will resume to work after 3s.</p> |
| Digital tube displays “H” with red slowly flashing | Too high temperature of controller | When heat sink of the controller exceeds 85 °C, the controller will automatically cut input and output circuit. When the temperature below 75°C, the controller will resume to work |



Notes: No LED indicator. Measure battery voltage with multimeter. Min.6V can start up the controller.



Notes: No charging status LED indicator with normal connection. Measure the input voltage of solar module, the input voltage must be higher than battery voltage!

5.3 Maintenance

The following inspections and maintenance tasks are recommended at least two times per year for best controller performance.

- Check that the controller is securely mounted in a clean and dry environment.
- Check that the air flow and ventilation around the controller is not blocked. Clear all dirt or fragments on the heat sink.
- Check all the naked wires to make sure insulation is not damaged for serious solarization, frictional wear, dryness, insects or rats etc. Maintain or replace the wires if necessary.
- Tighten all the terminals. Inspect for loose, broken, or burnt wire connections.
- Check and confirm that LED digital tube is consistent with required. Pay attention to any troubleshooting or error indication. Take necessary corrective action.
- Confirm that all the system components are ground connected tightly and correctly.
- Confirm that all the terminals have no corrosion, insulation damaged, high temperature or burnt/discolored sign, tighten terminal screws to the suggested torque.
- Inspect for dirt, insects and corrosion, and clear up.
- Check and confirm that lightning arrester is in good condition. Replace a new one in time to avoid damaging of the controller and even other equipments.



NOTE: Dangerous with electric shock! Make sure that all power source of controller is cut off when operate above processes, and then make inspection or other operations!

6. Warranty

The NSC charge controller is warranted to be free from defects for a period of TWO (2) years from the date of shipment to the original end user. We will, at its option, repair or replace any such defective products.

- **Claim procedure:**

Before requesting warranty service, check the Operation Manual to be certain that there is a problem with the controller. Return the defective product to us with shipping charges prepaid if problem cannot be solved. Provide proof of date and place of purchase. To obtain rapid service under this warranty, the returned products must include the model, serial number and detailed reason for the failure, the module type and size, type of batteries and system loads. This information is critical to a rapid disposition of your warranty claim.

● **This warranty does not apply under the following conditions:**

1. Damage by accident, negligence, abuse or improper use.
2. PV or load current exceeding the ratings of product.
3. Unauthorized product modification or attempted repair
4. Damaged occurring during shipment.
5. Damage results from acts of nature such as lightning, weather extremes
6. Irreclaimable mechanical damage.

7. Technical specifications

Electrical Parameters

Table 7-1

| Description | Parameter |
|--------------------------------|--------------------|
| Nominal System Voltage | 12/24VDC Auto work |
| Maximum Battery Voltage | 32V |
| Rated Battery Current | 10A |
| Charge Circuit Voltage Drop | ≤0.26V |
| Discharge Circuit Voltage Drop | ≤0.15V |
| Self-consumption | ≤6mA |

Threshold Voltage Parameters

Table 7-2

| Description | Parameter |
|-------------------------------------|------------|
| NTTV (Night Time Threshold Voltage) | 5V; x2/24V |
| DTTV (Day Time Threshold Voltage) | 6V; x2/24V |

Temperature Compensation Coefficient

Table 7-3

| Description | Parameter |
|---|------------------------|
| Temperature Compensation Coefficient(TEMPCO)* | -5mV/°C/12V (25°C ref) |

*Compensation of equalize, boost, float and boost reconnect voltage.

Battery Voltage Parameters (temperature at 25°C)

Table 7-4

| Charging Parameters | | | |
|---|--------------|---------------|----------------|
| Battery charging setting | Gel | Sealed | Flooded |
| Over Voltage Disconnect Voltage | 16V; x2/24V | 16V; x2/24V | 16V; x2/24V |
| Charging Limit Voltage | 15.5V;x2/24V | 15.5V;x2/24V | 15.5V;x2/24V |
| Equalize Charging Voltage | ----- | 14.6V;x2/24V | 14.8V;x2/24V |
| Boost Charging Voltage | 14.2V;x2/24V | 14.4V;x2/24V | 14.6V;x2/24V |
| Float Charging Voltage | 13.8V;x2/24V | 13.8V;x2/24V | 13.8V;x2/24V |
| Boost Reconnect Charging Voltage | 13.2V;x2/24V | 13.2V;x2/24V | 13.2V;x2/24V |
| Low Voltage Reconnect Voltage | 12.6V;x2/24V | 12.6V;x2/24V | 12.6V;x2/24V |
| Under voltage warning reconnect voltage | 12.2V;x2/24V | 12.2V;x2/24V | 12.2V;x2/24V |
| Under Voltage Warning Voltage | 12V; x2/24V | 12V; x2/24V | 12V; x2/24V |
| Low Voltage Disconnect Voltage | 11.1V;x2/24V | 11.1V;x2/24V | 11.1V;x2/24V |
| Discharging Limit Voltage | 10.8V;x2/24V | 10.8V;x2/24V | 10.8V;x2/24V |
| Equalize duration | ----- | 2 hours | 2 hours |
| Boost duration | 2 hours | 2 hours | 2 hours |

Environmental parameters

Table 7-5

| Environmental parameters | Parameter |
|---------------------------------|------------------|
| Working temperature | -35°C to +55°C |
| Storage temperature | -35°C to +80°C |
| Humidity | ≤95% N.C. |
| Enclosure | IP30 |

NSC1024R Mechanical Parameters

Table 7-6

| Mechanical Parameter | Parameter |
|-----------------------------|---------------------------------------|
| Overall dimension | 140(5.51)x65(2.56)x34(1.34) mm/inches |
| Mounting dimension | 130(5.12) x 45(1.7) mm/inches |
| Mounting hole size | Φ4.5 |
| Terminal | 4mm ² |
| Net weight | 0.15kg |